

1 : 50

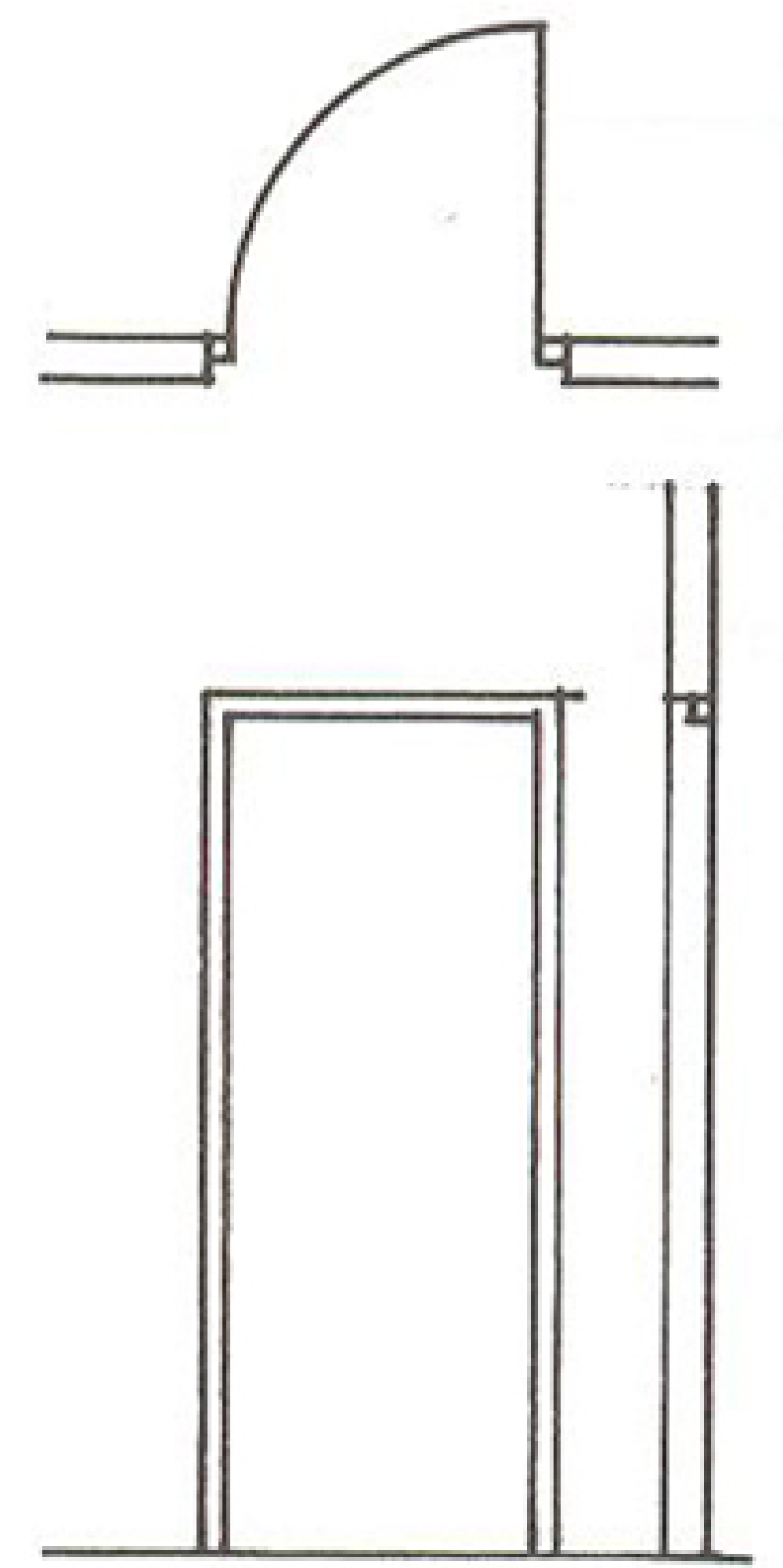

1 : 100

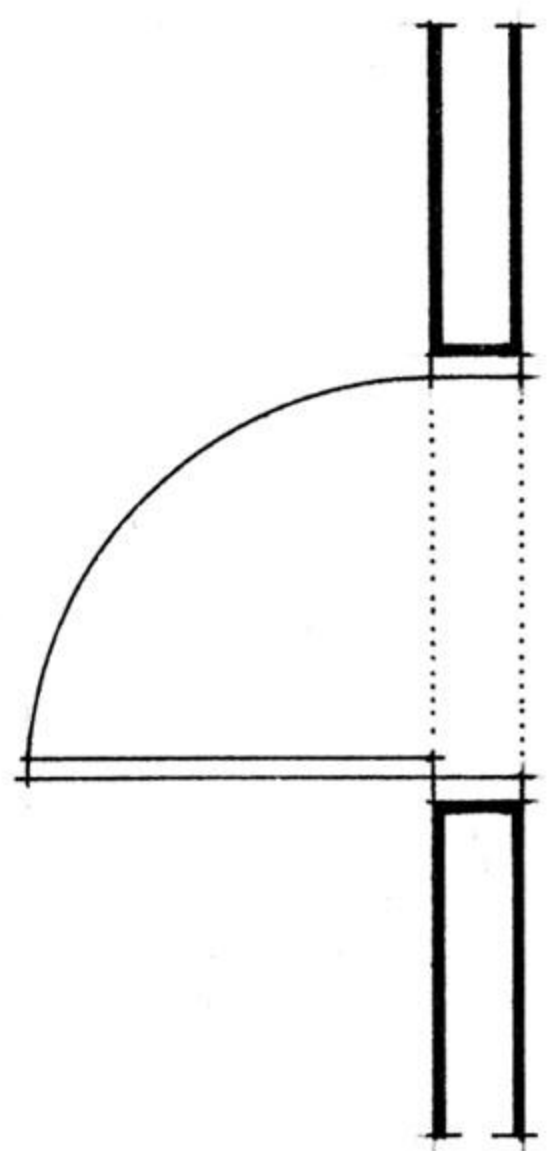

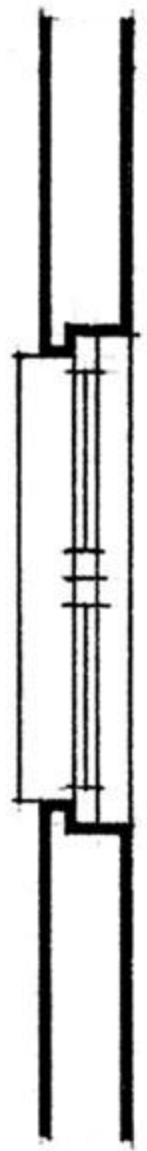
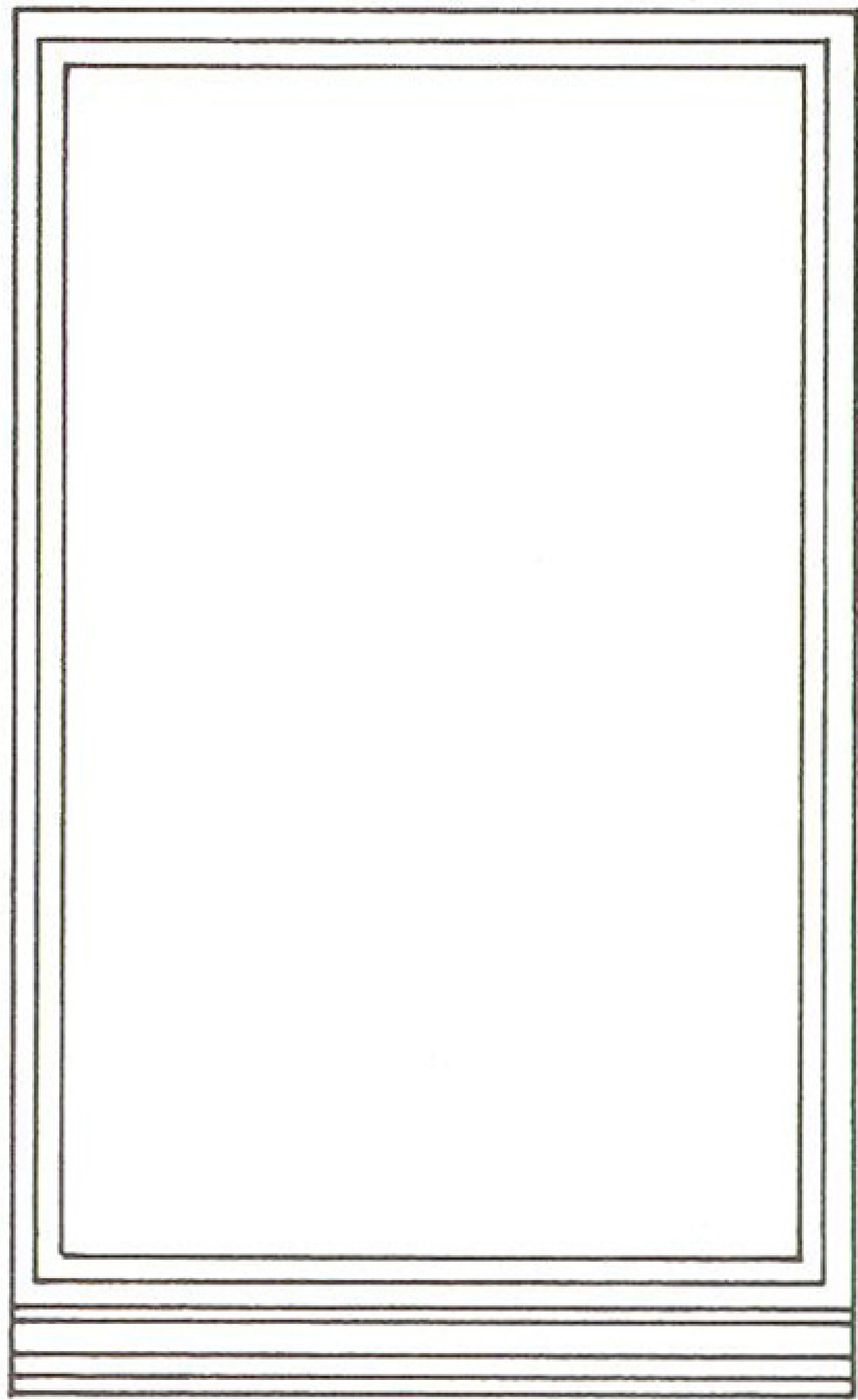
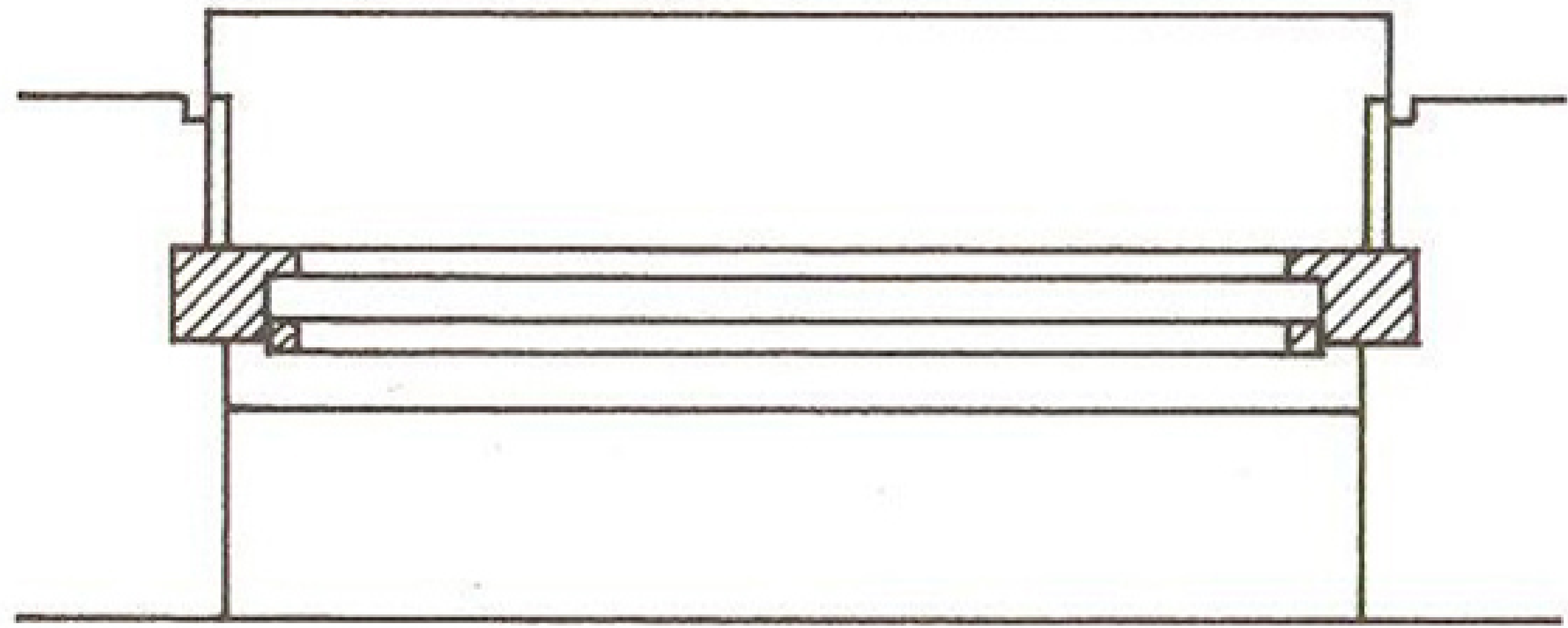

1 : 20

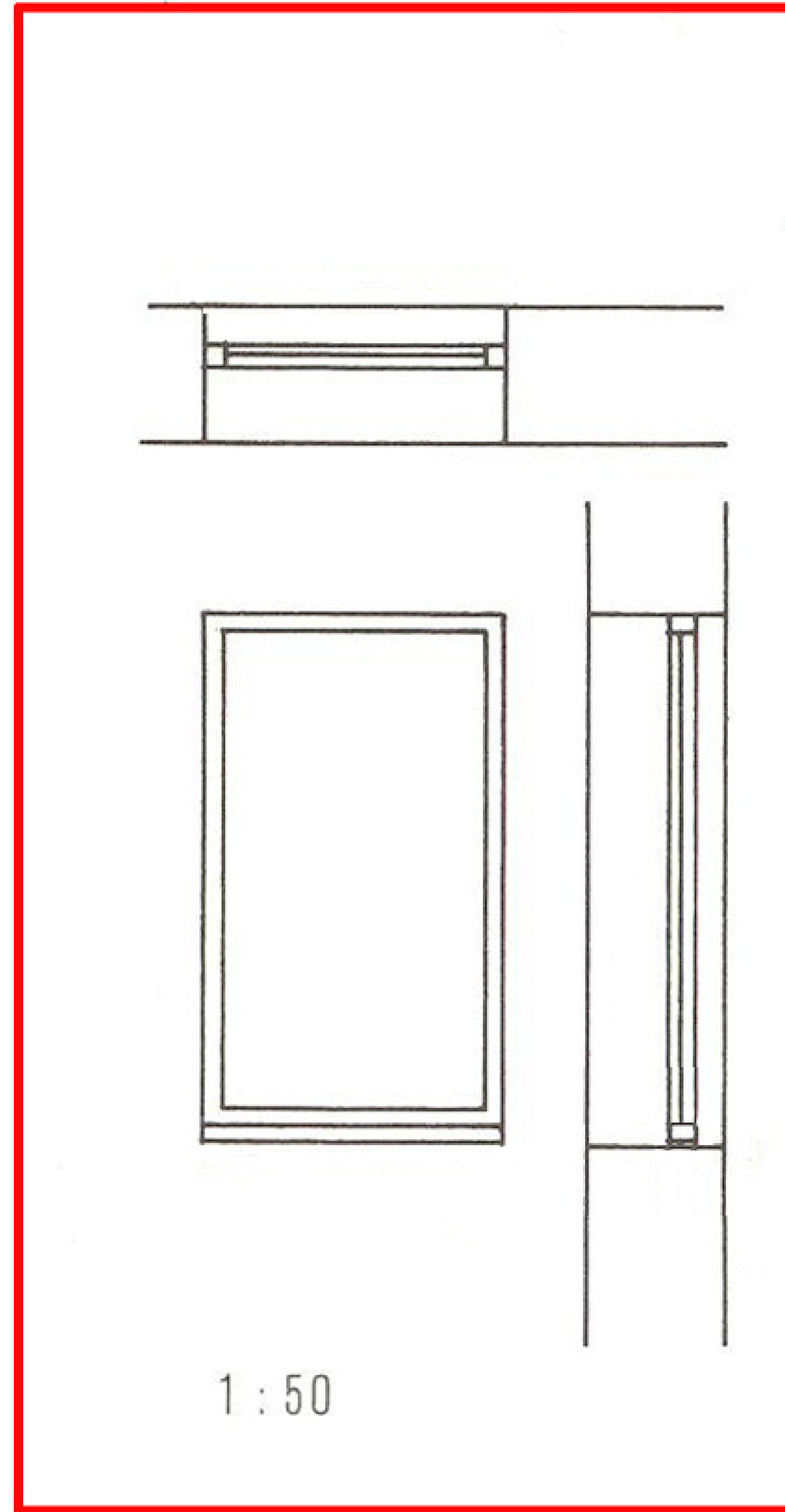
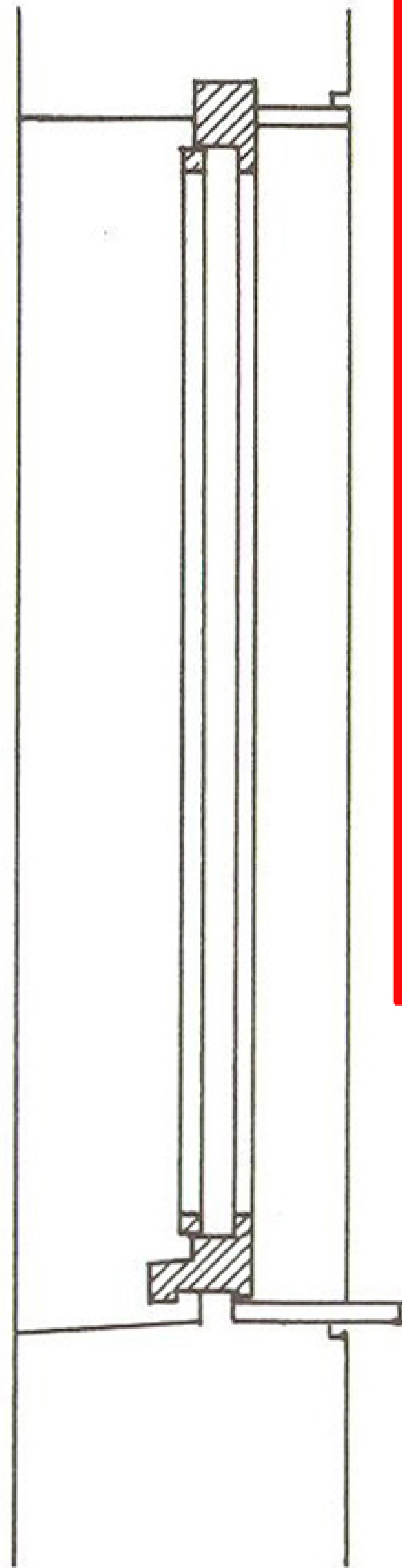

1 : 50

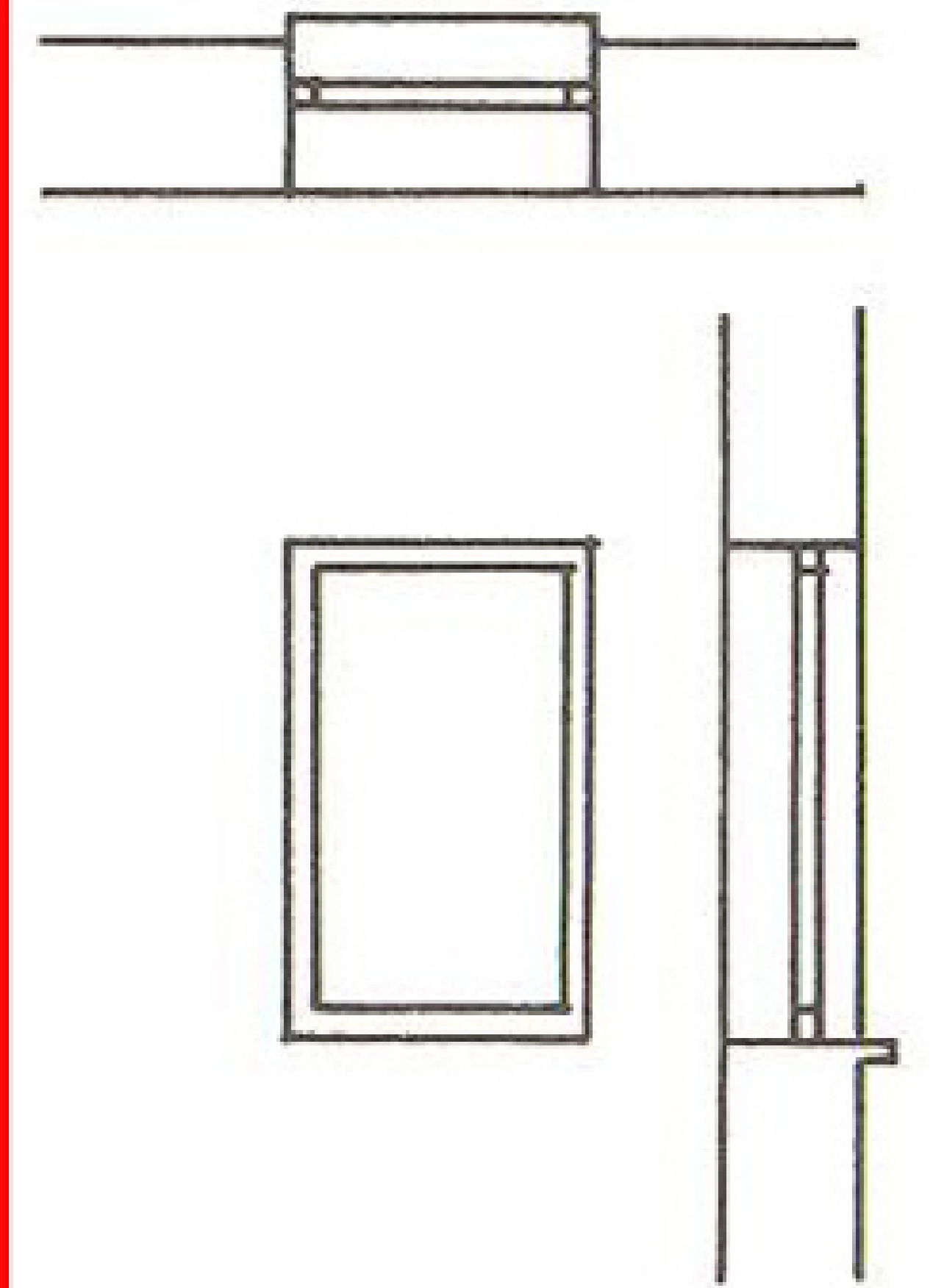

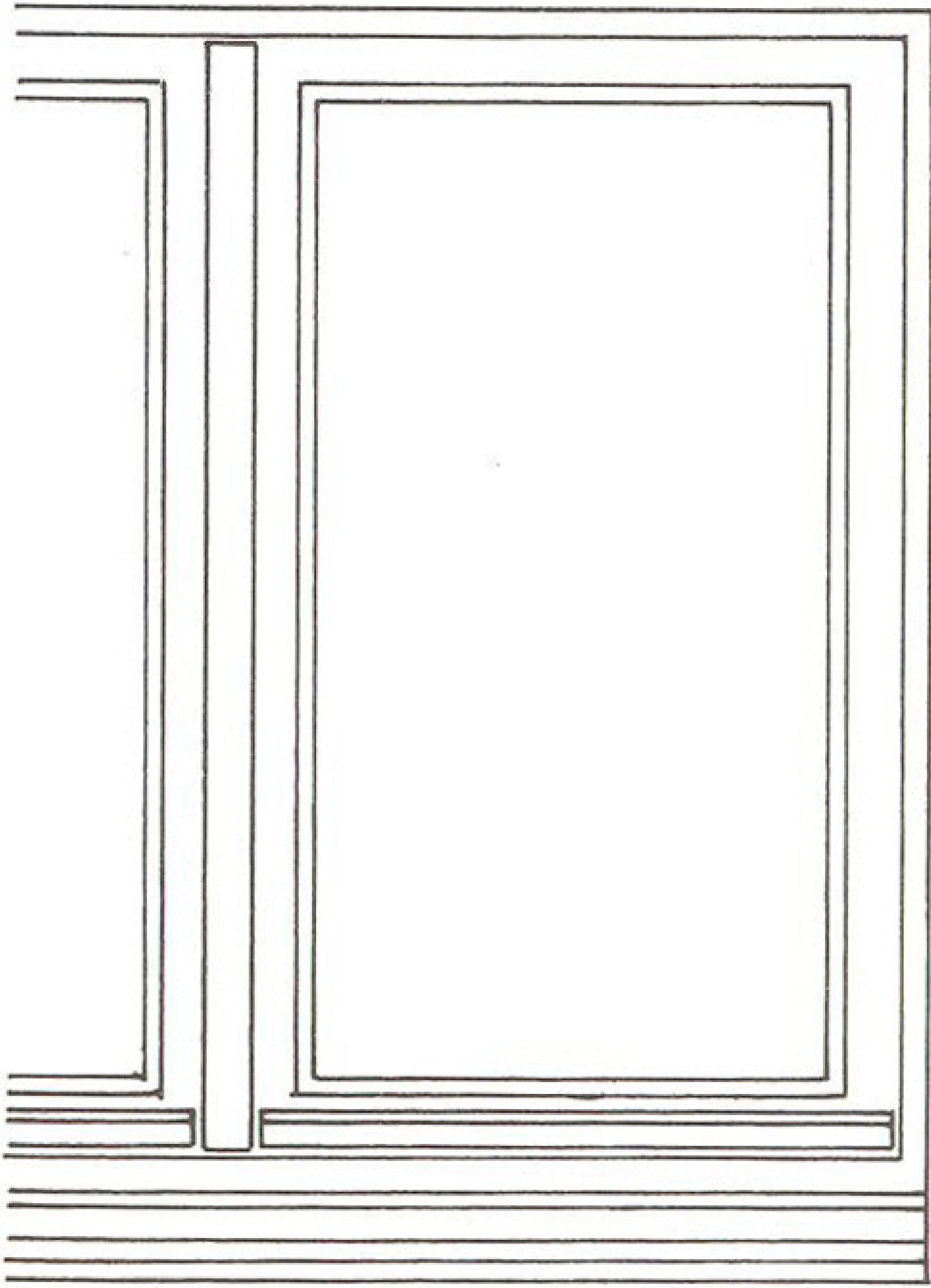
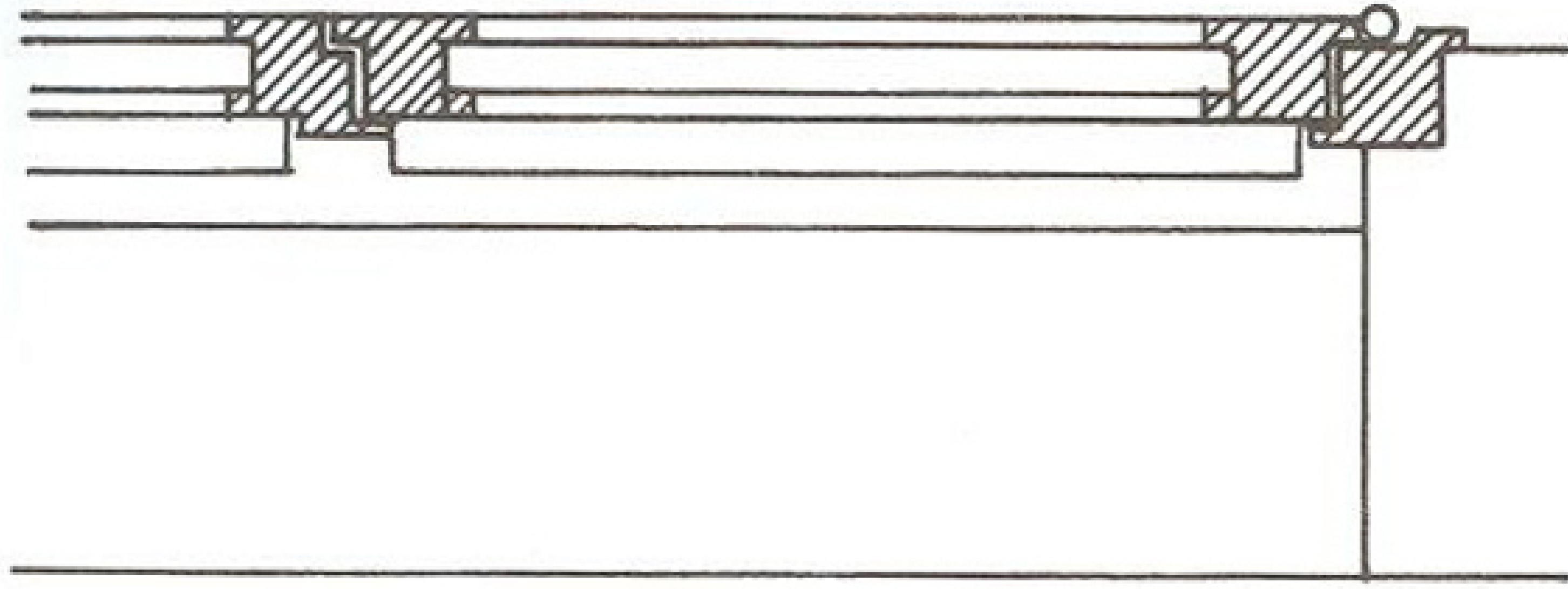

1 : 20

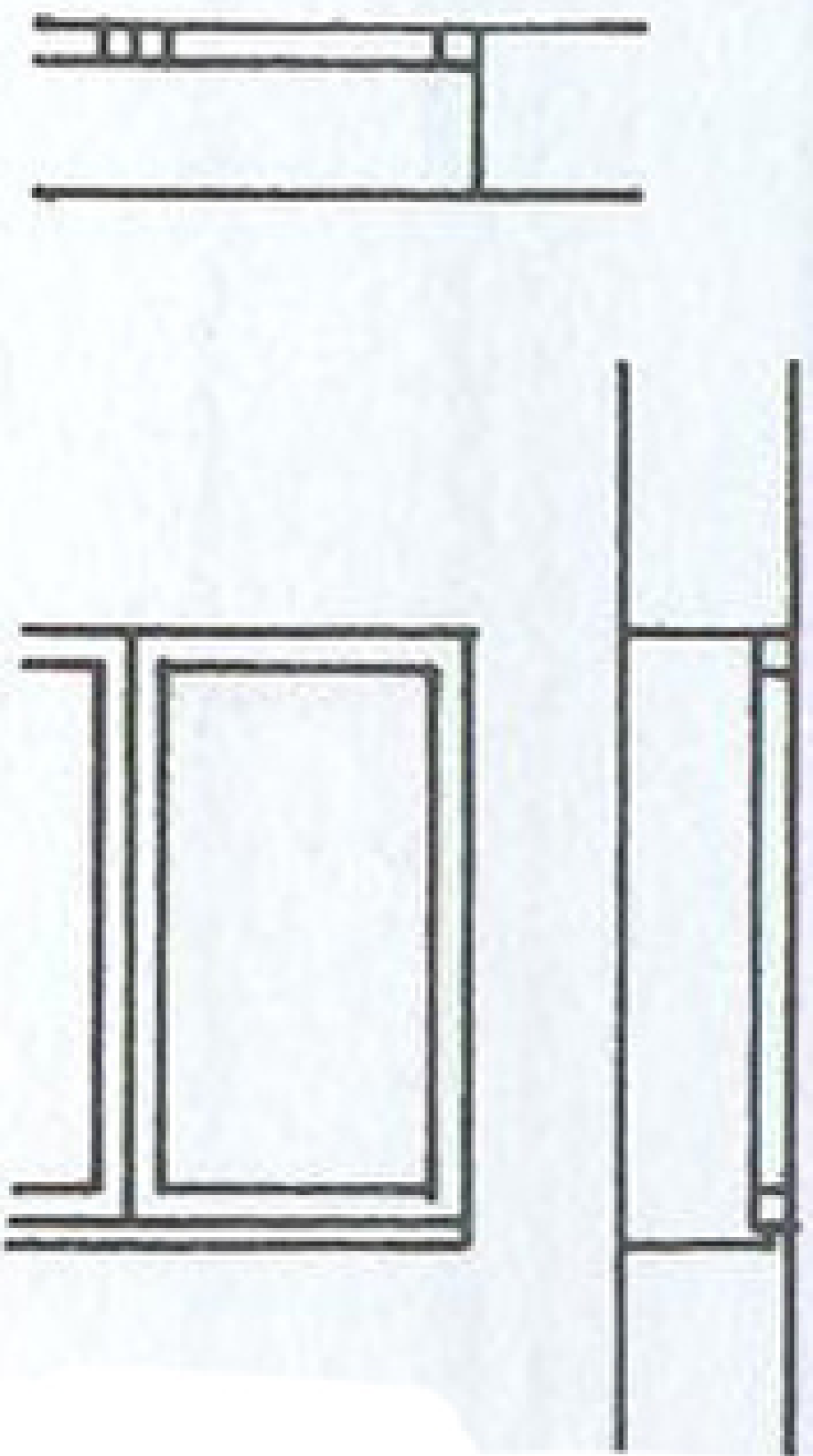
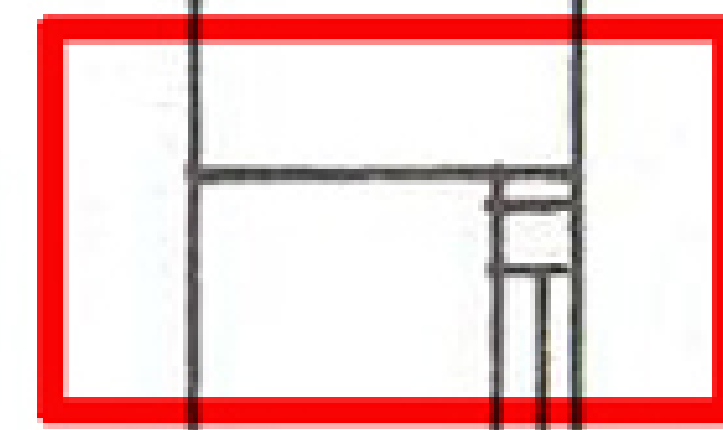
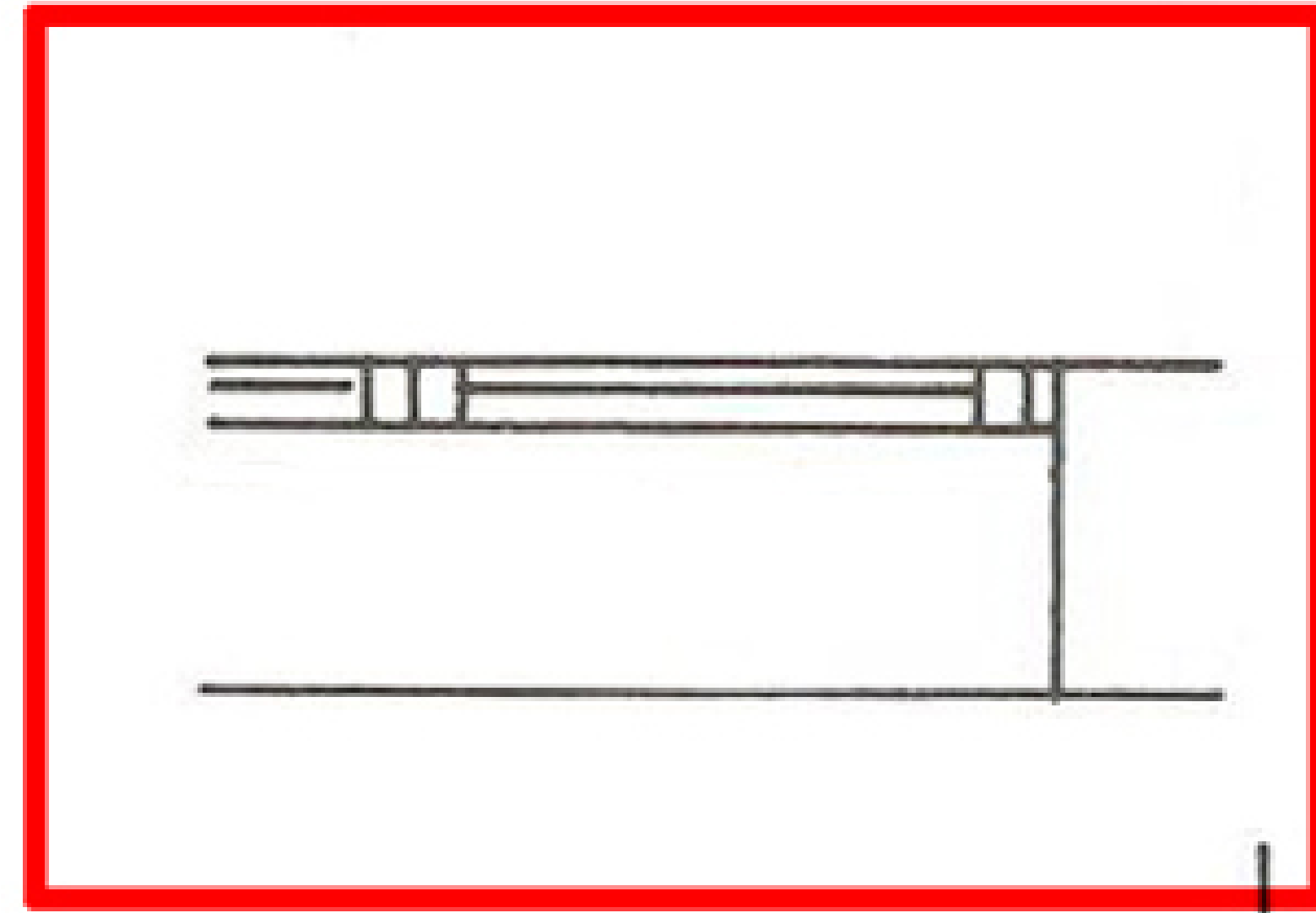
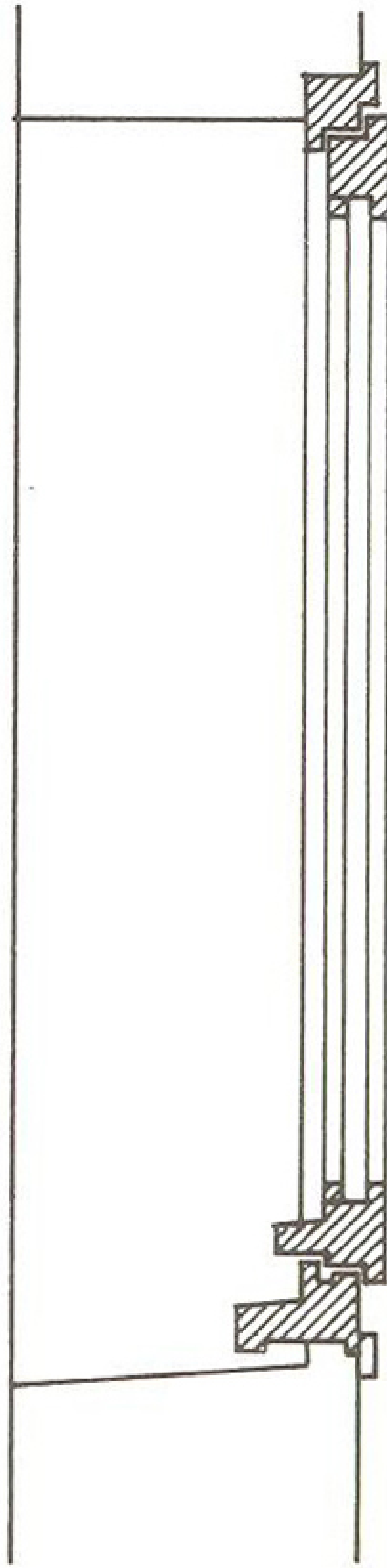

1 : 50

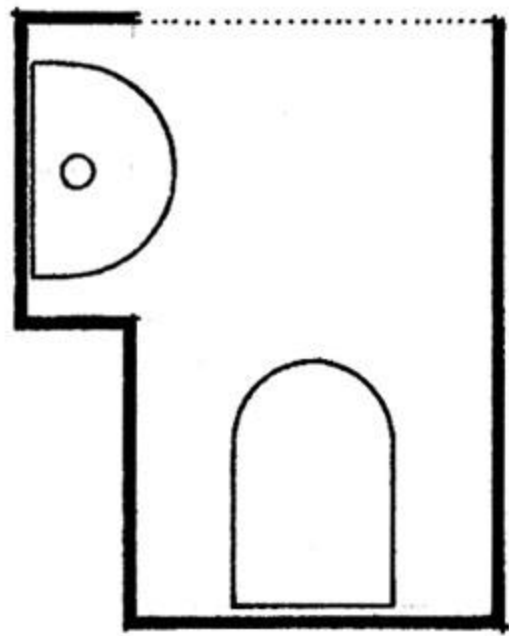
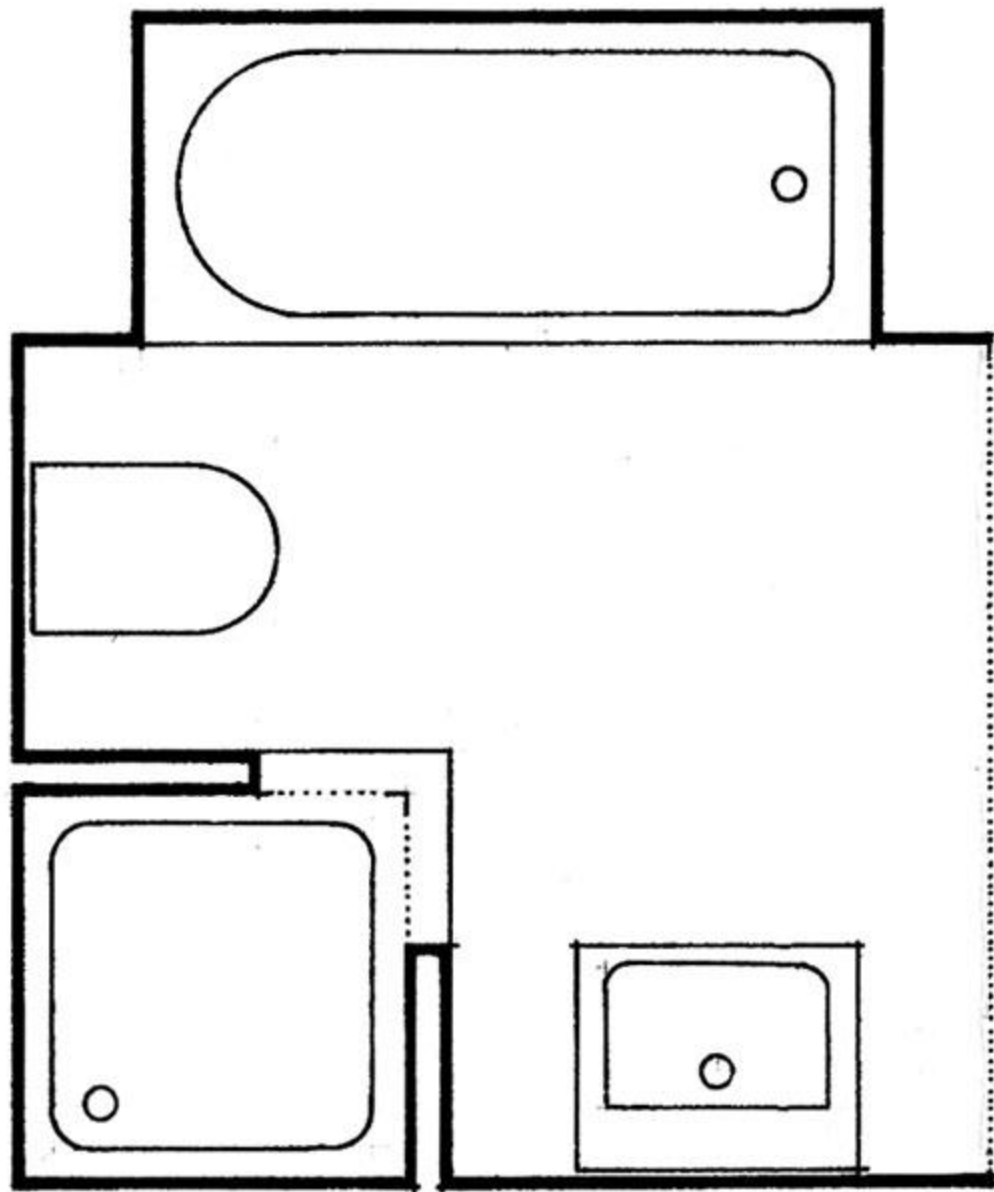

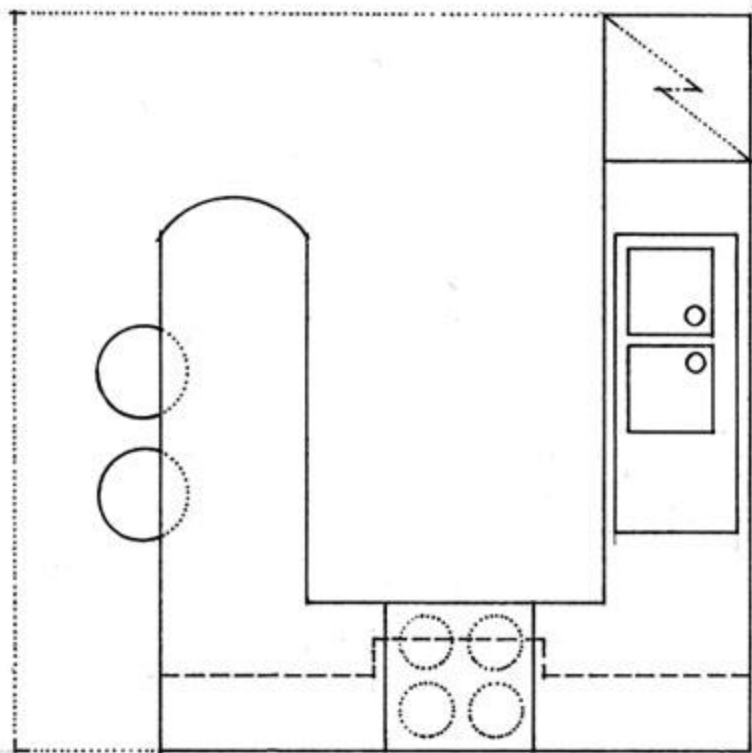
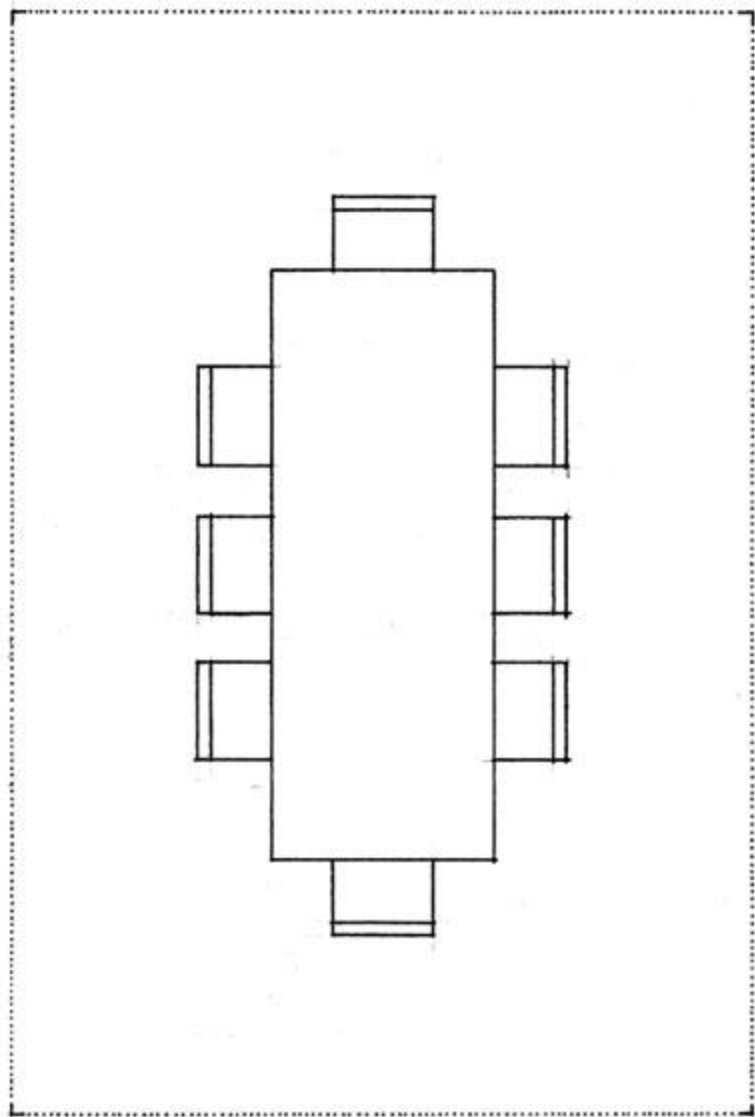

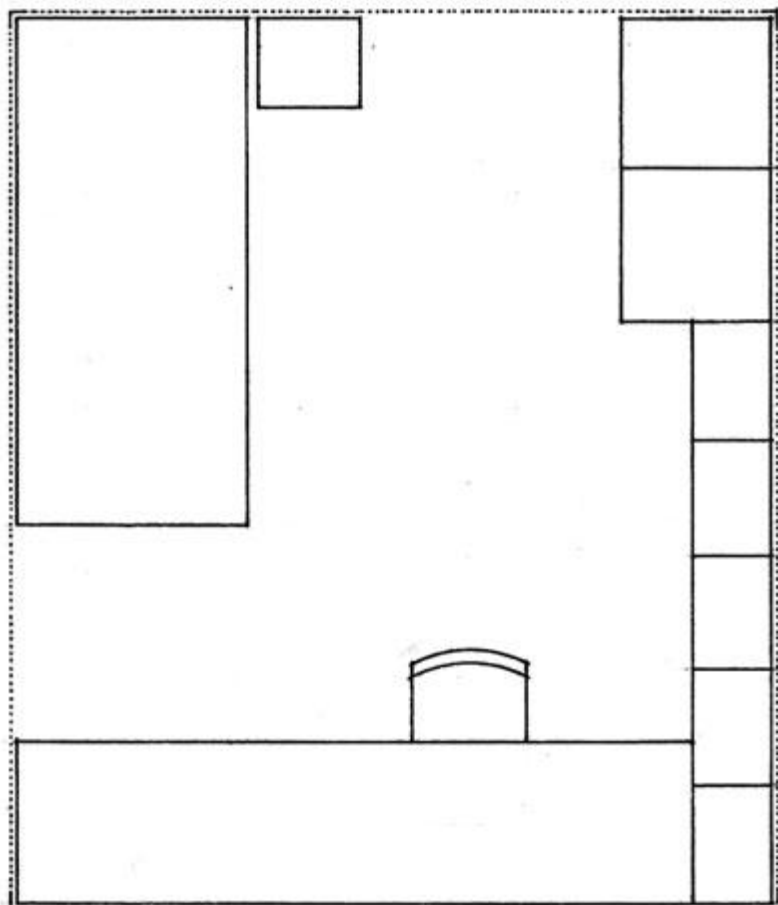
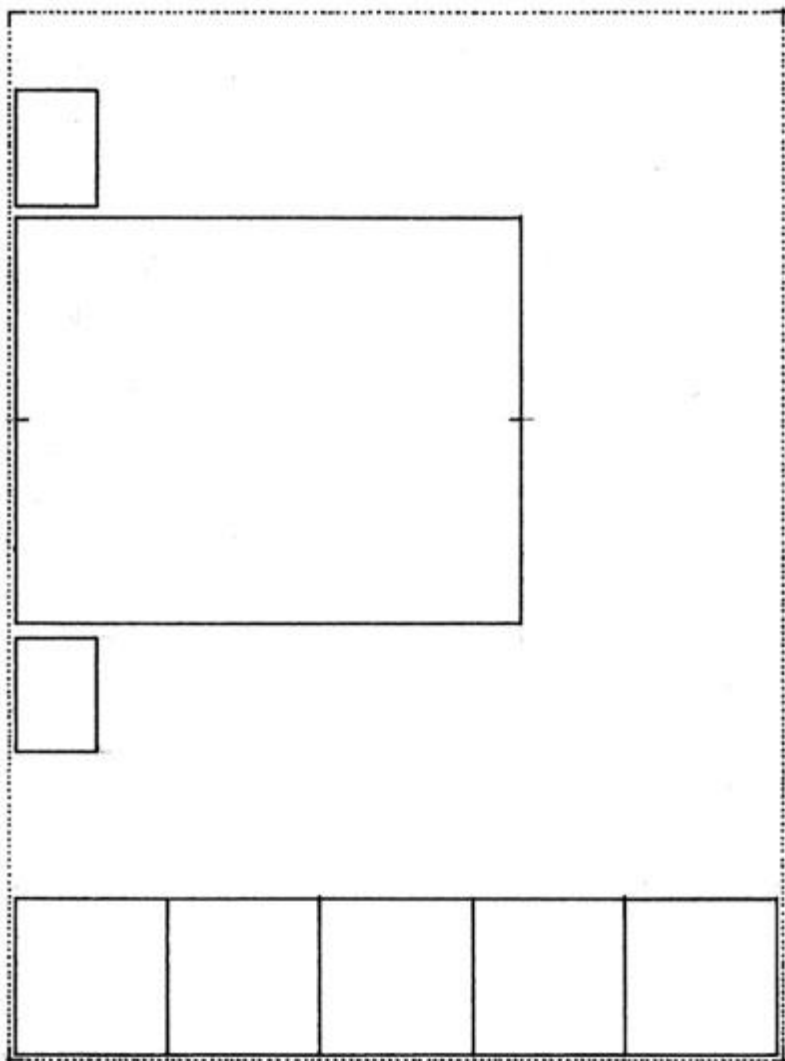

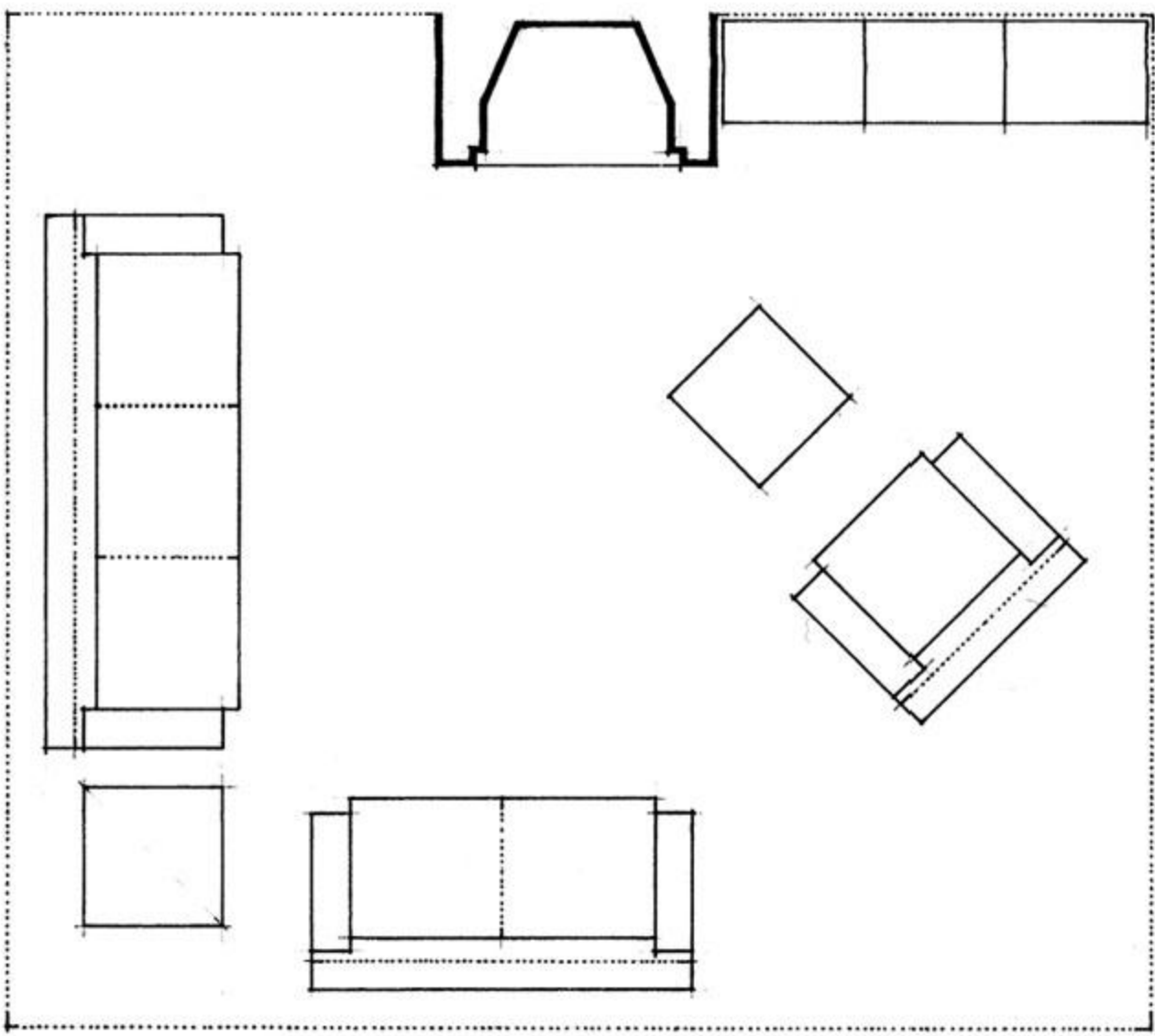



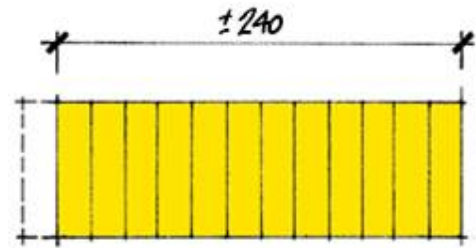
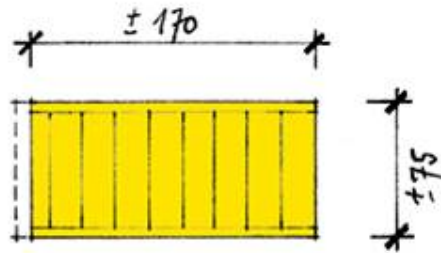
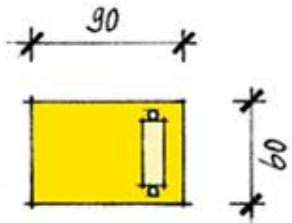
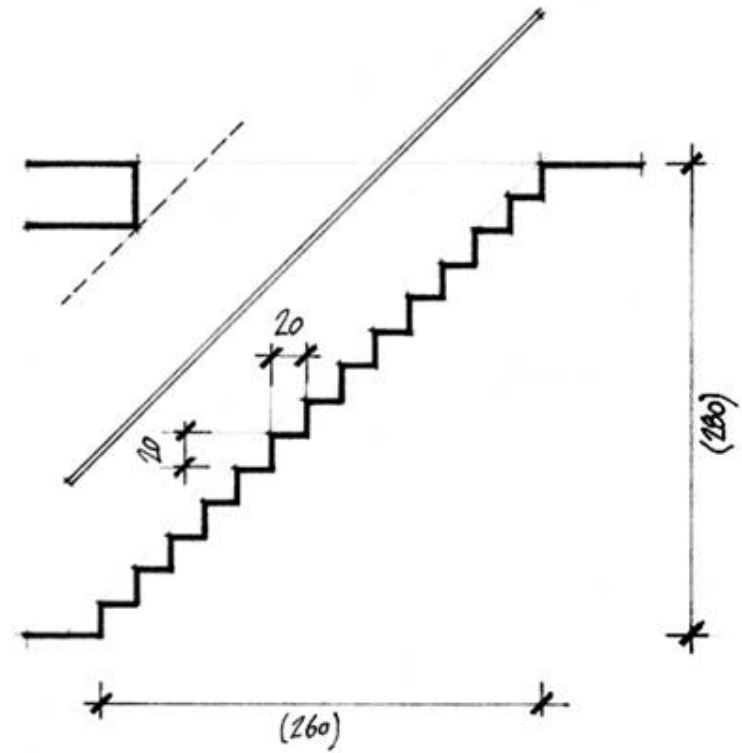
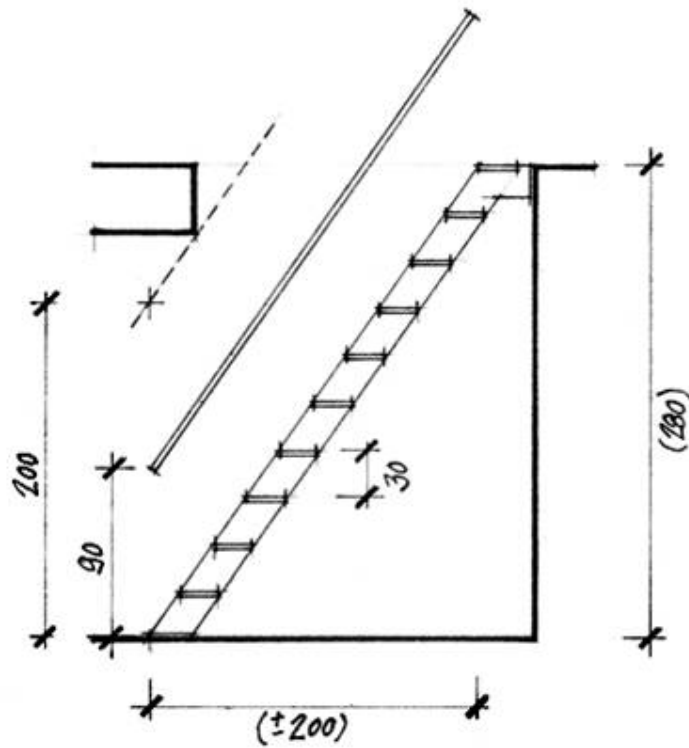
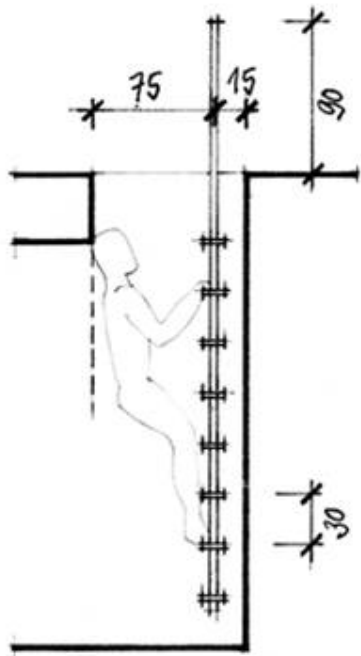

EHELLE

EHELLE DE MEUNIER.

ESCALIER DE CAVE.

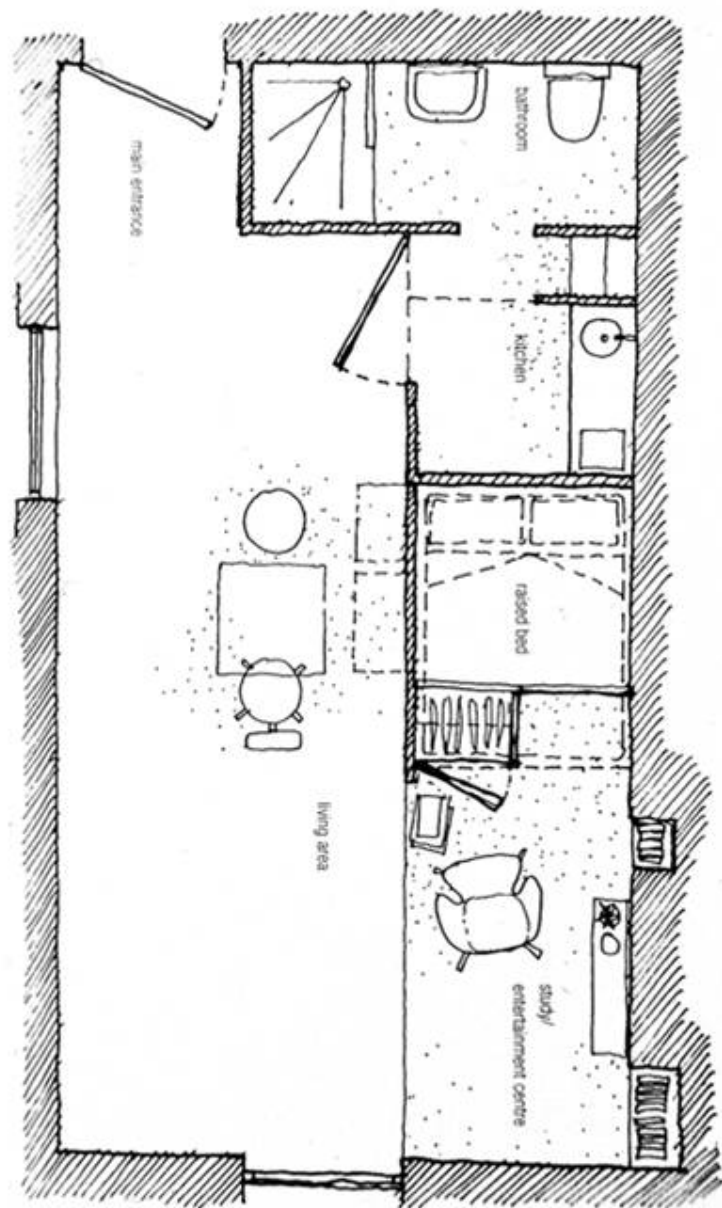

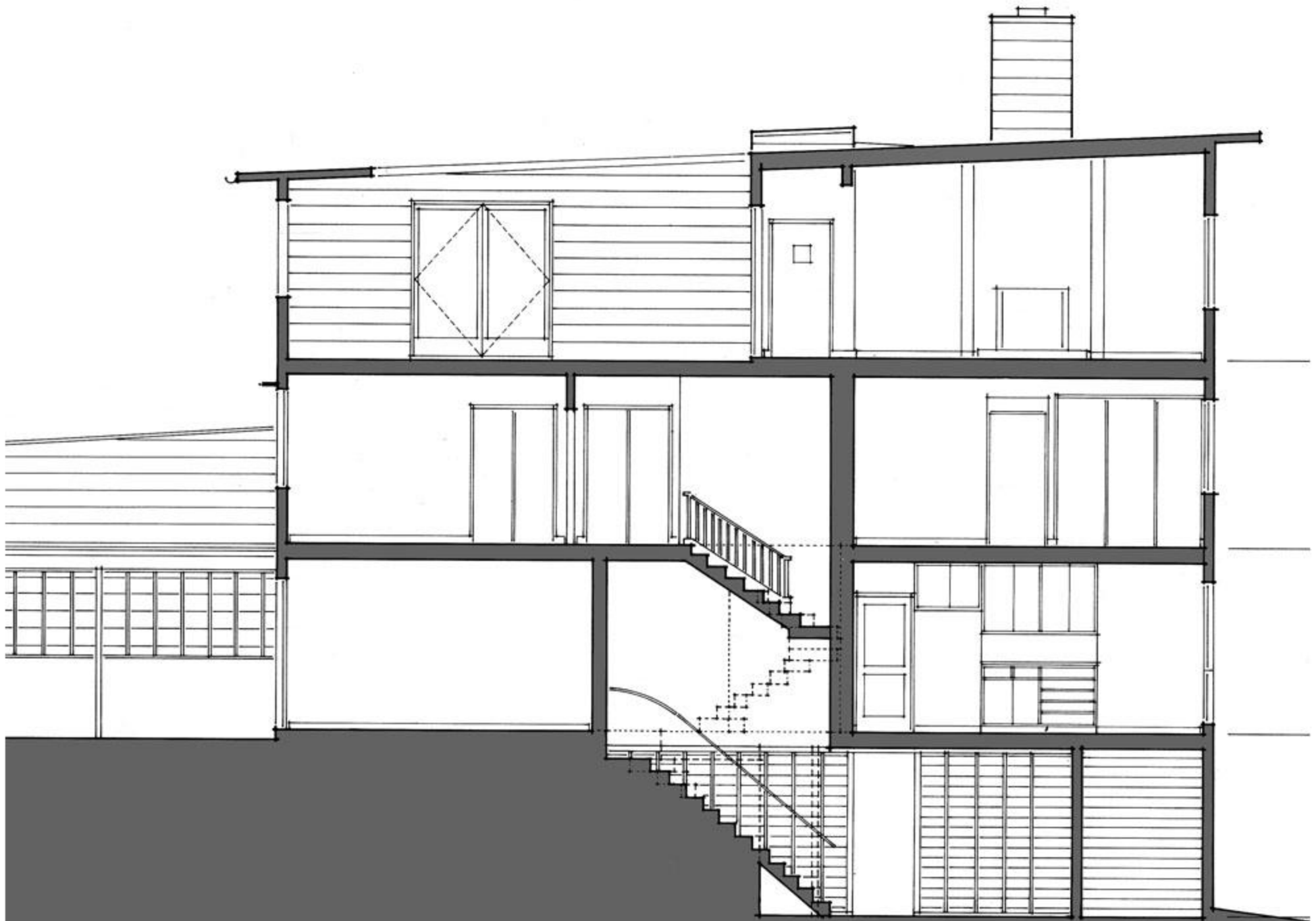

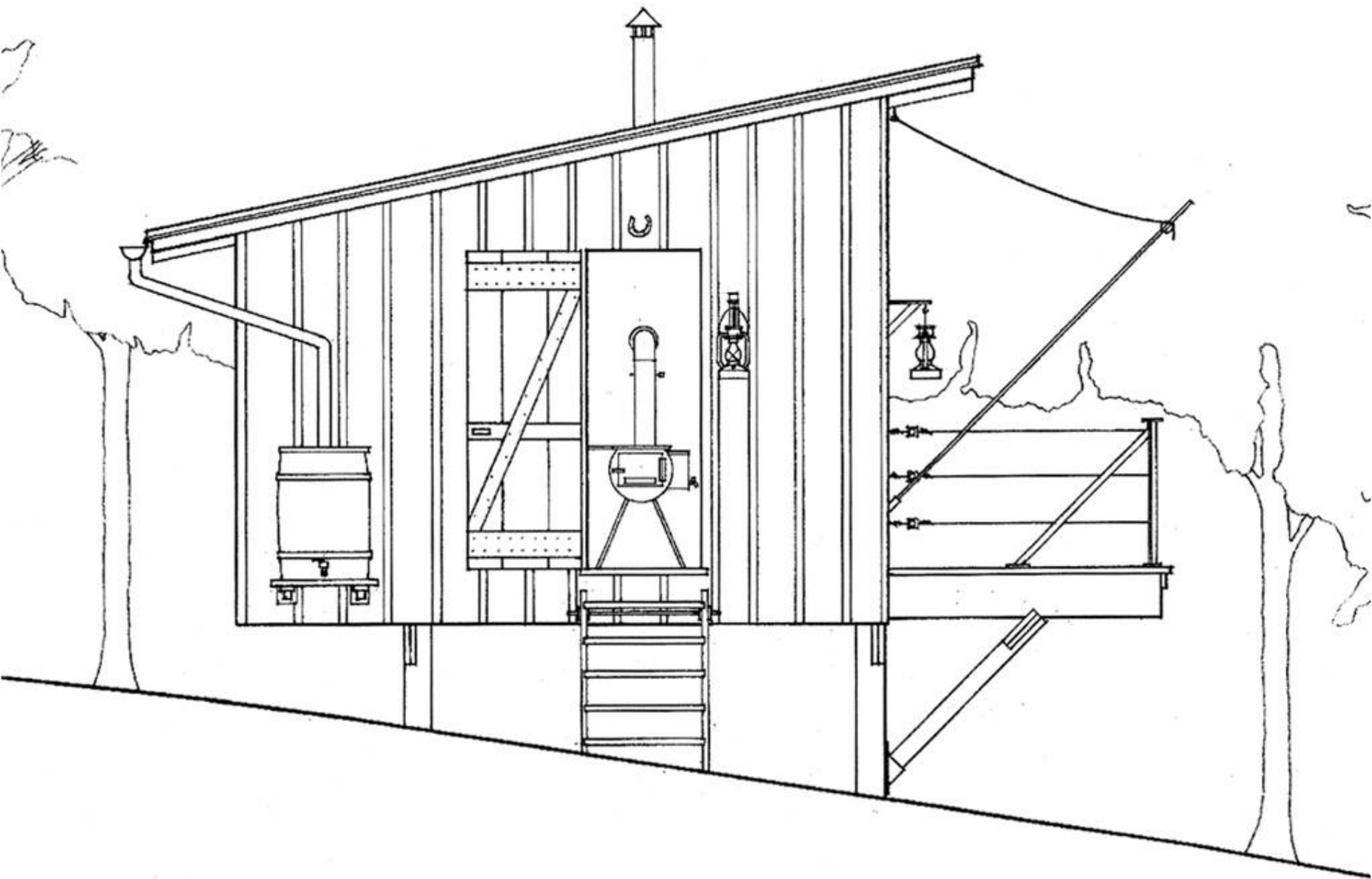

Projection latérale (accès)